

5278296PCOM CARVER STORAGE CABINET

Ameriwood
HOME

Date of Purchase: ____/____/____
Lot Number:

B345278296PCOM01

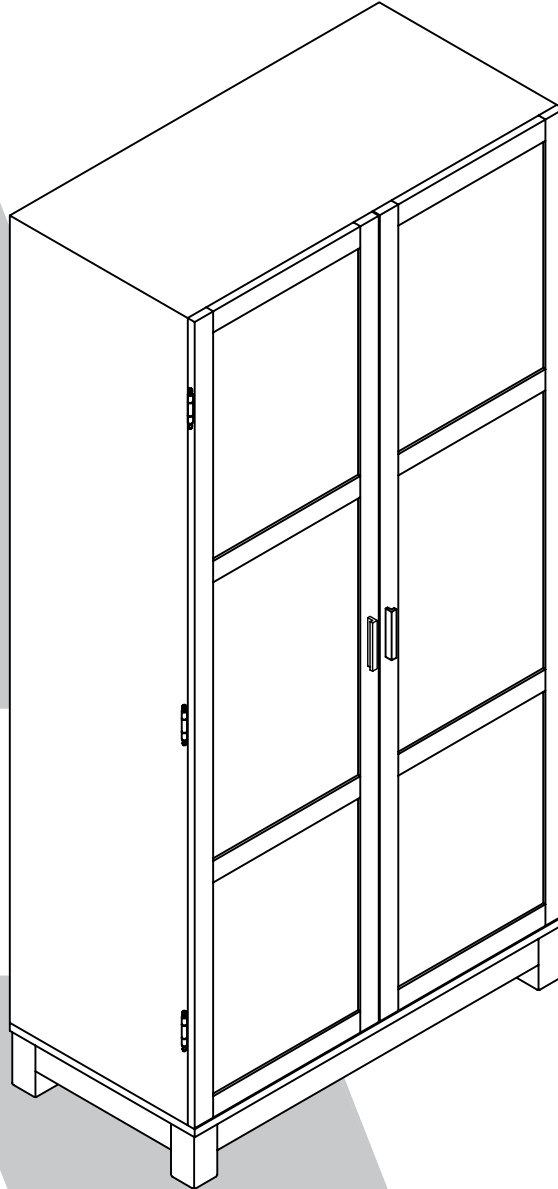

THIS INSTRUCTION BOOKLET CONTAINS **IMPORTANT** SAFETY INFORMATION. PLEASE READ AND KEEP FOR FUTURE REFERENCE.

Do Not Return This Product!

Contact our customer service team for help first
Call: 1-800-489-3351 (toll free)
Monday-Friday 9am - 5pm CST
Visit: www.ameriwoodhome.com



WARNING

- Unit can tip over causing severe injury or death.
- Anchor unit to stud in wall (if instructed to)
- Do not allow children climb on unit
- Put heavy items on lower shelves or drawers

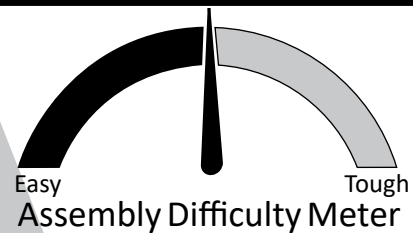

Follow Ameriwood Home



Contact Us!

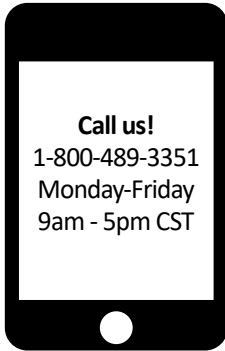

Do NOT return this product!
Contact our friendly customer service team first for help

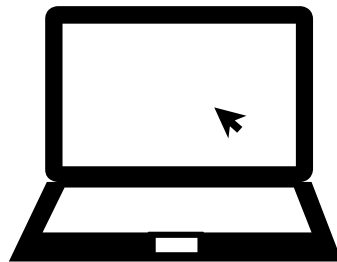

Visit ameriwoodhome.com

Assembly Tips



Helpful Hints

PEOPLE NEEDED FOR ASSEMBLY: **1-2**
ESTIMATED ASSEMBLY TIME: **1 HOUR**

- Open your item in the area you plan to keep it for less heavy lifting
- Identify, sort and count the parts before attempting assembly
- Compression dowels are tapped in with a hammer
- Slides are labeled with a R (right) and L (left) for proper placement
- Make sure to always face the point on the top of the Cam Lock towards the outer edge
- Use all the nails provided for the back panel and spread them out equally
- Back Panel must be used to make sure your unit is sturdy
- Do NOT use harsh chemicals or abrasive cleaners on this item
- Never push, pull, or drag your furniture



Before You Start

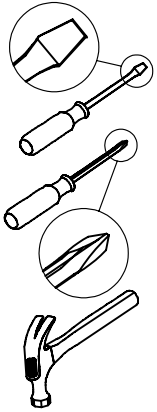
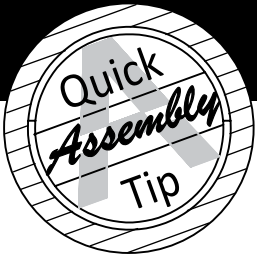

- ✓ Read through each step carefully and follow the proper order
- ✓ Separate and count all your parts and hardware
- ✓ Give yourself enough room for the assembly process
- ✓ Have the following tools: Flat Head Screwdriver, #2 Phillips Head Screwdriver and Hammer
- ✓ Caution: If using a power drill or power screwdriver for screwing, please be aware to slow down and stop when screw is tight. Failure to do so may result in stripping the screw.

Cam Lock Fastening System

This Cam Lock Fastening System will be used throughout the assembly process.

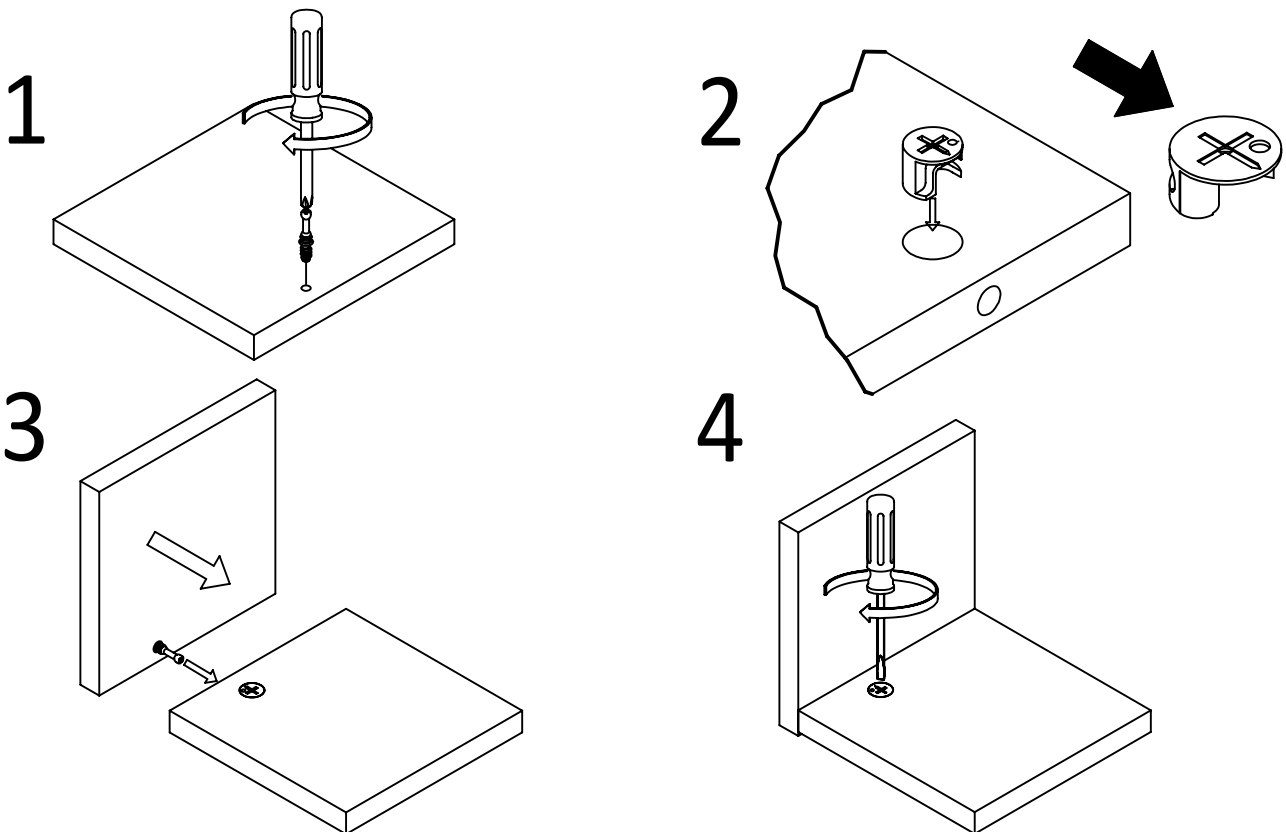

Board Identification

Not actual size

1

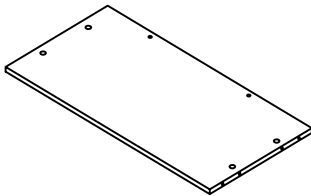

x1
T5278296011UD
TOP PANEL

2

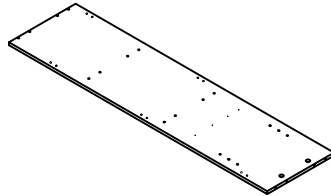

x1
T5278296021UD
LEFT SIDE PANEL

3

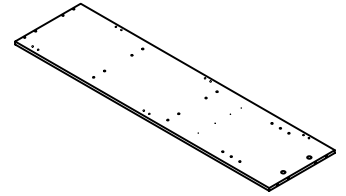

x1
T5278296031UD
RIGHT SIDE PANEL

4

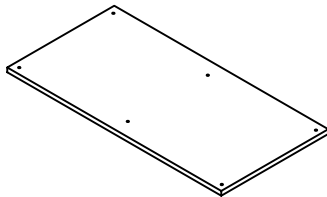

x1
T5278296040UD
BOTTOM PANEL

5

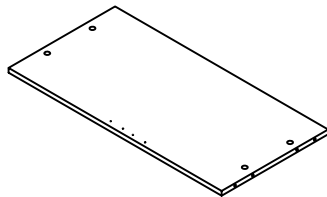

x1
T5278296051UD
FIXED SHELF

6

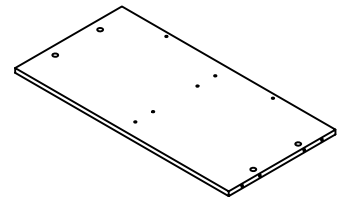

x1
T5278296061UD
FIXED SHELF

7

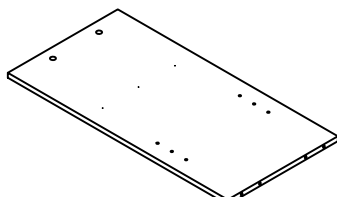

x1
T5278296070UD
MIDDLE PARTITION

8

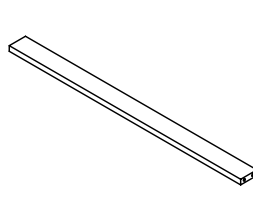

x1
T5278296080UD
TOP APRON

9

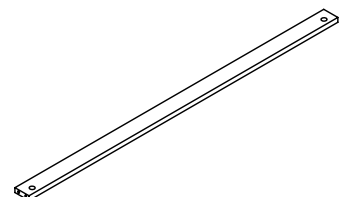

x2
T5278296090UD
LONG LOWER RAIL

Board Identification

Not actual size

10

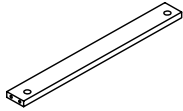

x2
T5278296100UD
SHORT LOWER RAIL

11



x4
T5278296110UD
FOOT

12

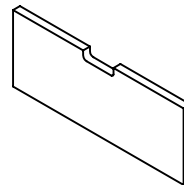

x2
T5278296120UD
DRAWER FRONT

13

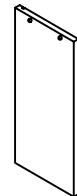

x2
T5278296130UD
LEFT DRAWER SIDE

14

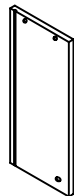

x2
T5278296140UD
RIGHT DRAWER SIDE

15

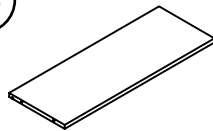

x2
T5278296150UD
DRAWER BACK

16

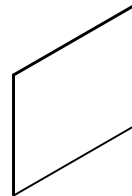

x2
T5278296160UD
DRAWER BOTTOM

17

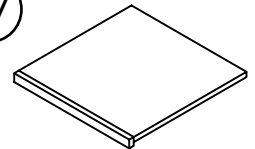

x2
T5278296170UD
ADJUSTABLE SHELF

18

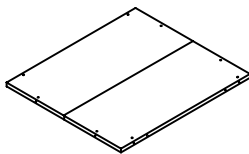

x1
T5278296181UD
UPPER BACK PANEL

19

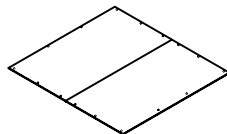

x1
T5278296191UD
LOWER BACK PANEL

20

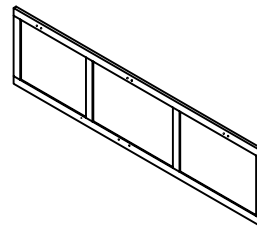

x1
T5278296200UD
LEFT DOOR

21

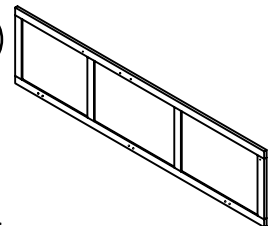

x1
T5278296210UD
RIGHT DOOR

Part List

Actual Size



x38
TUD0001
Cam Bolt
M6 X 23

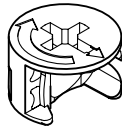

x38
TUD0002
Cam Lock
15-12



x40
TUD0004
DOWEL
M8 X 25

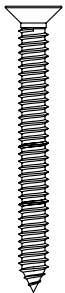

x14
TUD0009
CBS 4 x 38

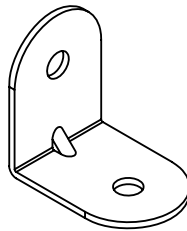

x2
TUD0020
L-BRACKET



x24
TUD0011
PH SCREW
M4 X 12



x20
TUD0034
PH SCREW
M3.5 X 12

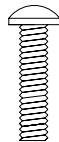

x4
TUD0010
PH SCREW
M4 X 18

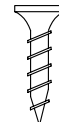

x32
TUD0008
CBS SCREW
M3.5 X 16

Part List

Not Actual Size

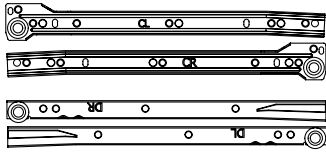

x2 SETS
TUD0017
DRAWER SLIDE 14"

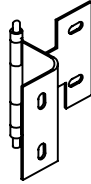

x6
TUD0046
HINGES

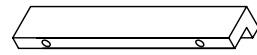

x2
TUD0032
HANDLE



x8
TUD0035
SHELF SUPPORT

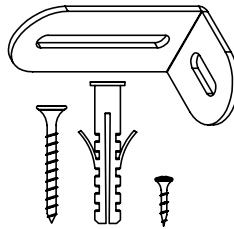

x1 set
TUD0021
ANTI TIPPING KIT

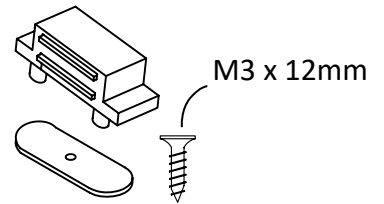

x4 SETS
TUD0031
MAGNETIC
CATCH

Step 1

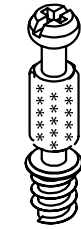
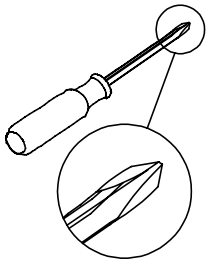

x14
TUD0001



x8
TUD0004

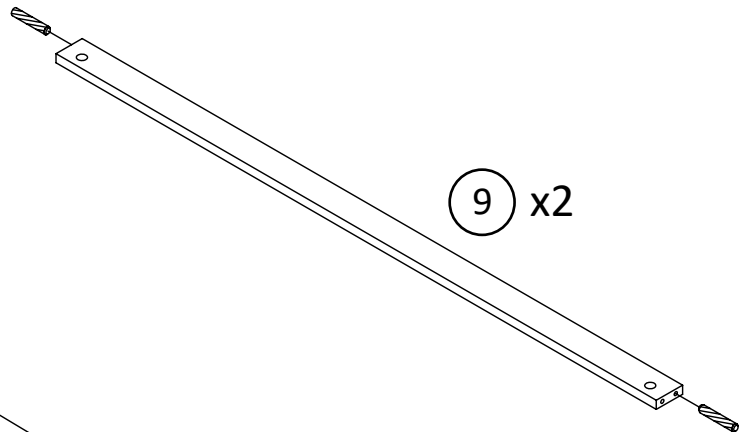
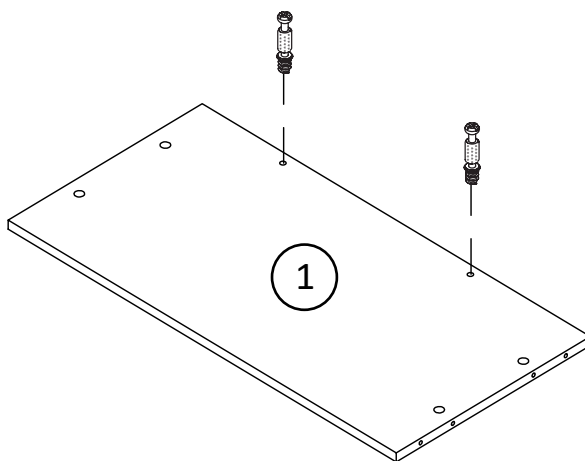
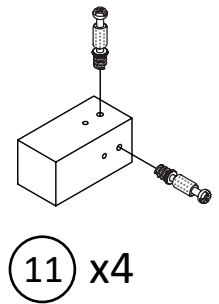
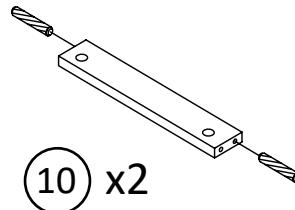
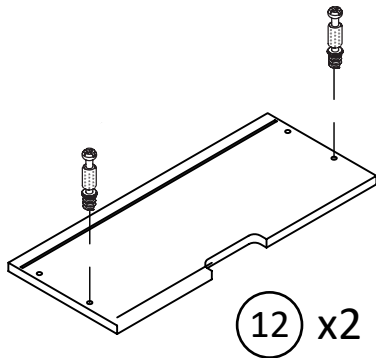
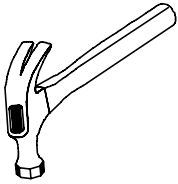
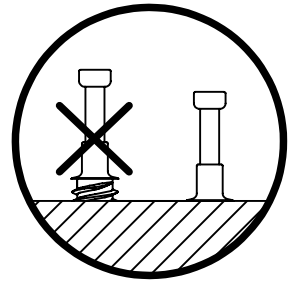

* raw edges are shaded

Step 2

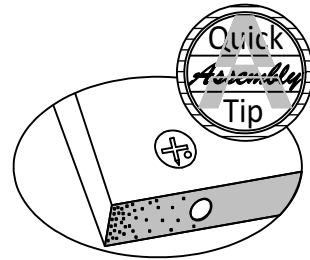
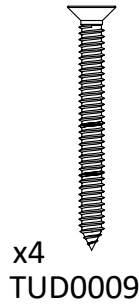
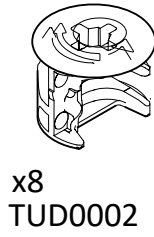
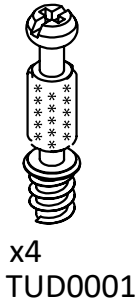
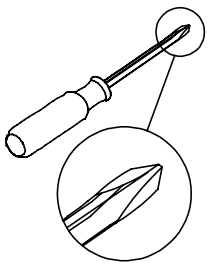

Proper orientation of CAM LOCK

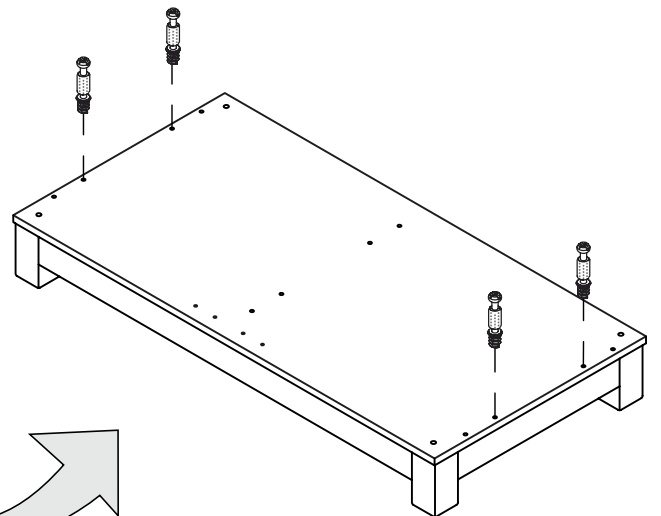
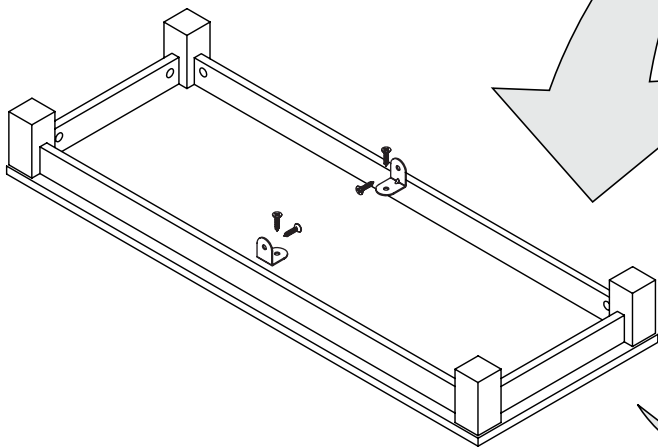
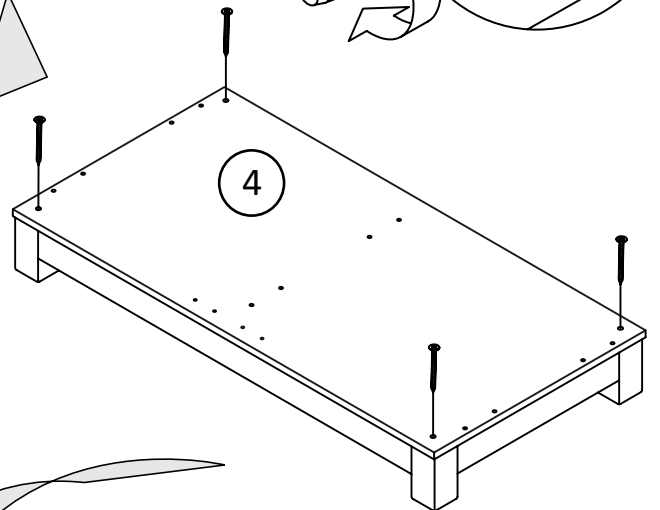
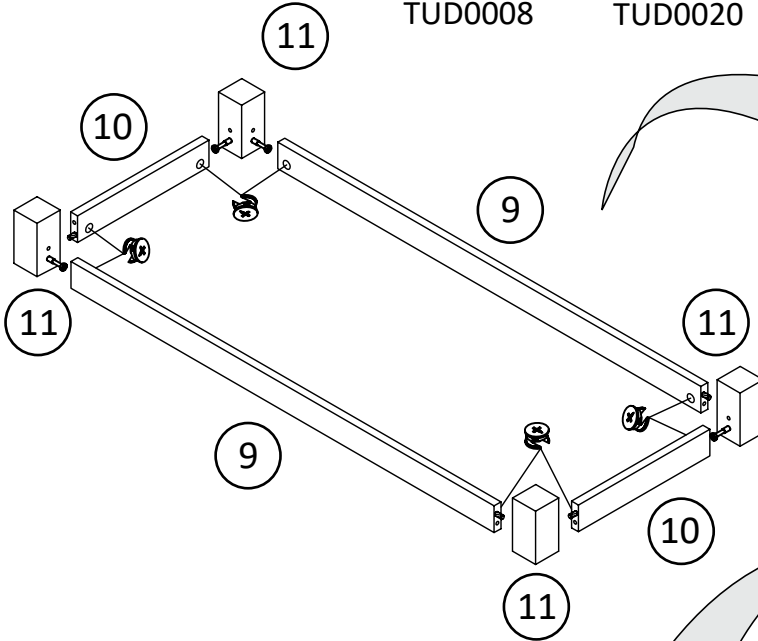
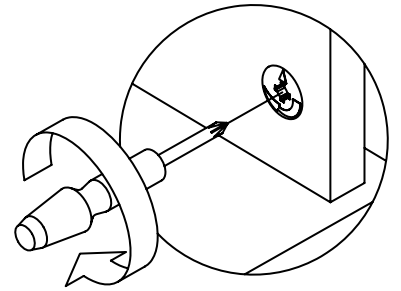
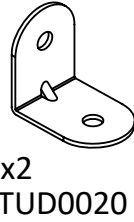
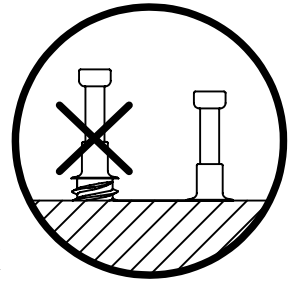

* raw edges are shaded

Step 3

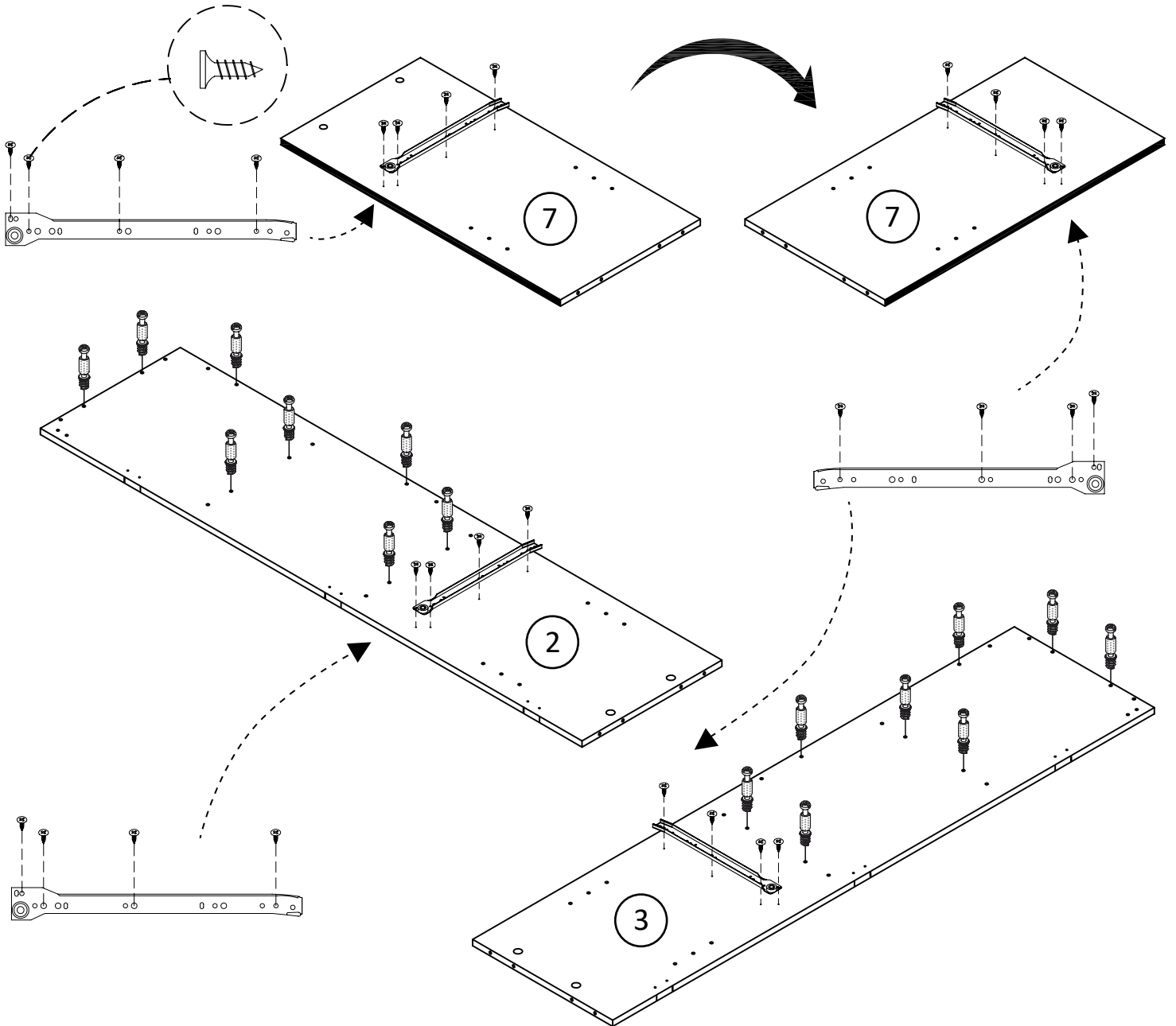
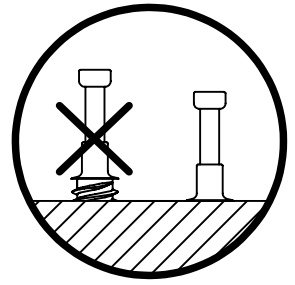
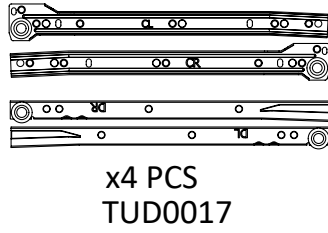
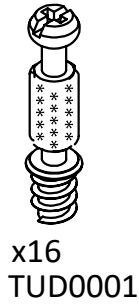
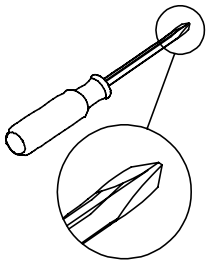

* raw edges are shaded

Step 4

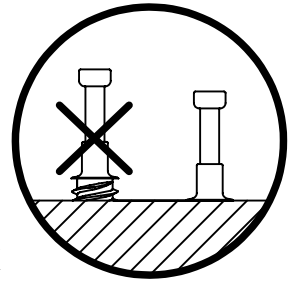
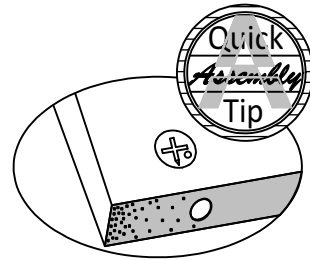
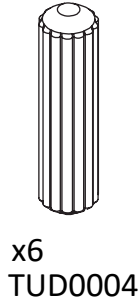
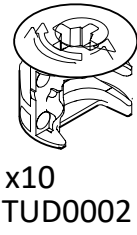
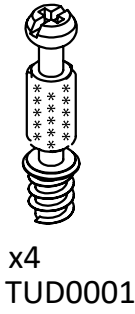
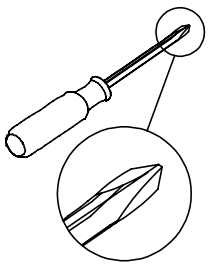

Proper orientation of CAM LOCK

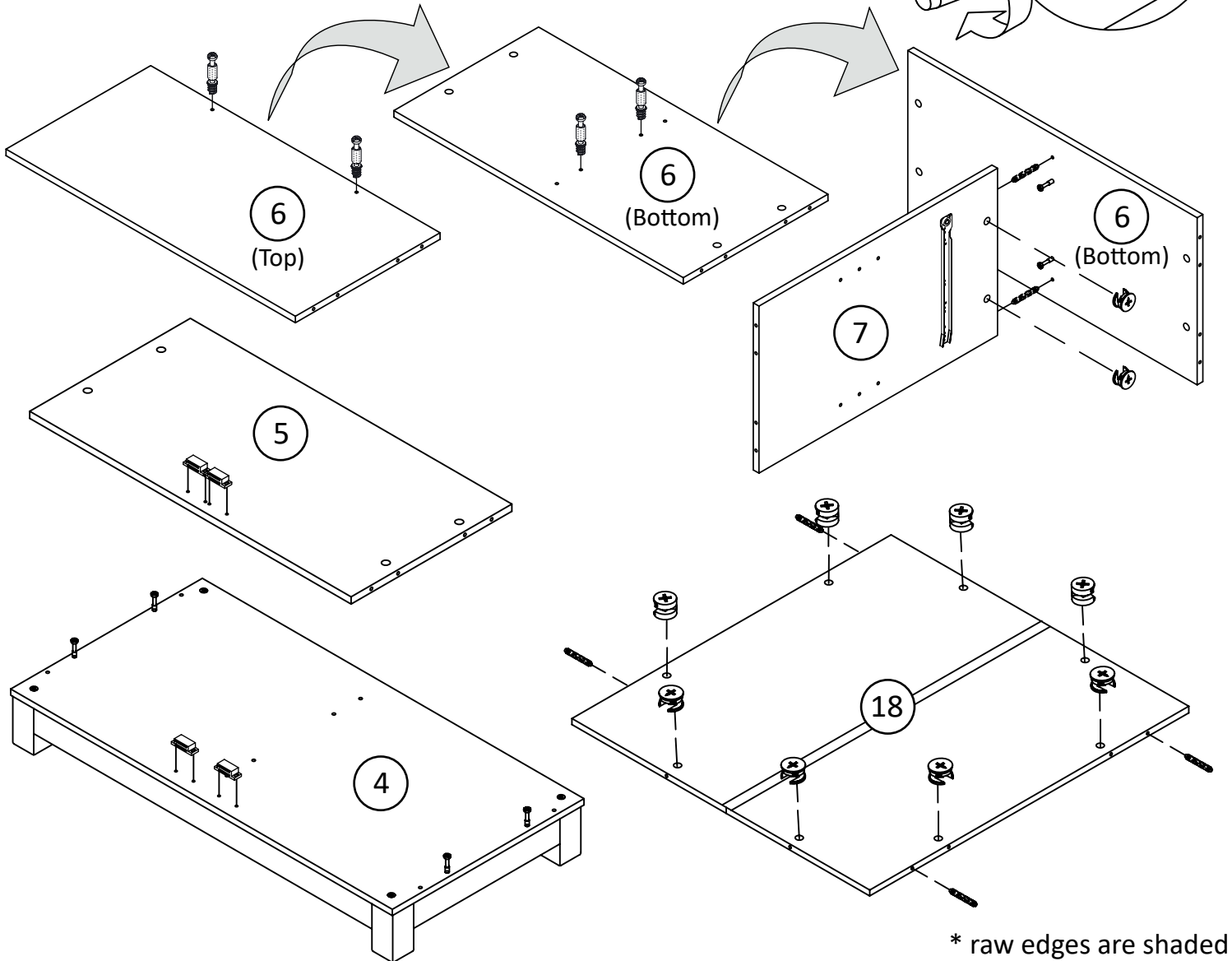
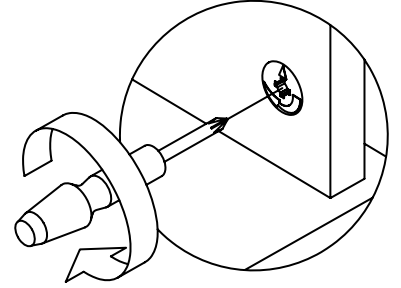
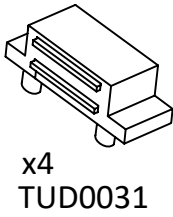
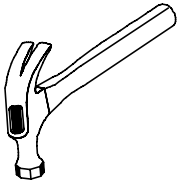

* raw edges are shaded

Step 5

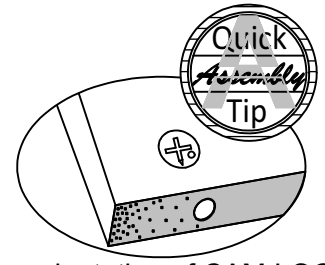
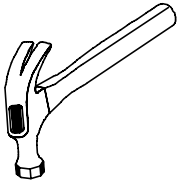
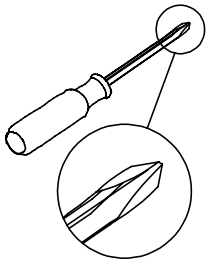

Proper orientation of CAM LOCK

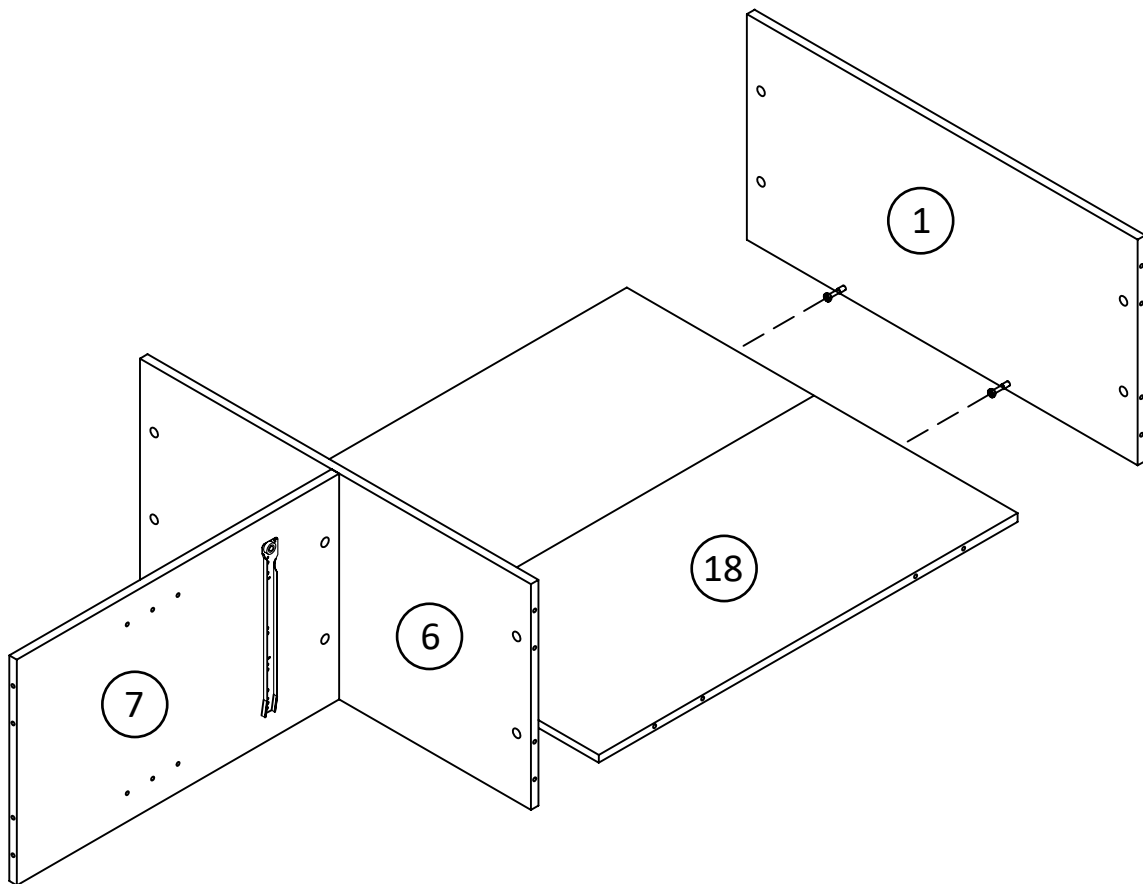

* raw edges are shaded

Step 6

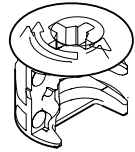
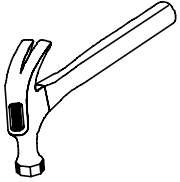
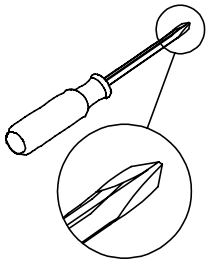

x6
TUD0002

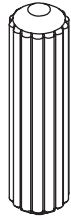

x8
TUD0004

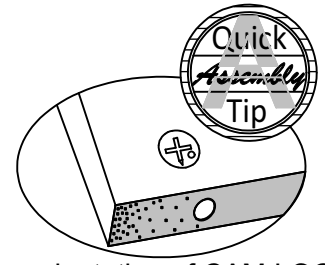

Proper orientation of CAM LOCK

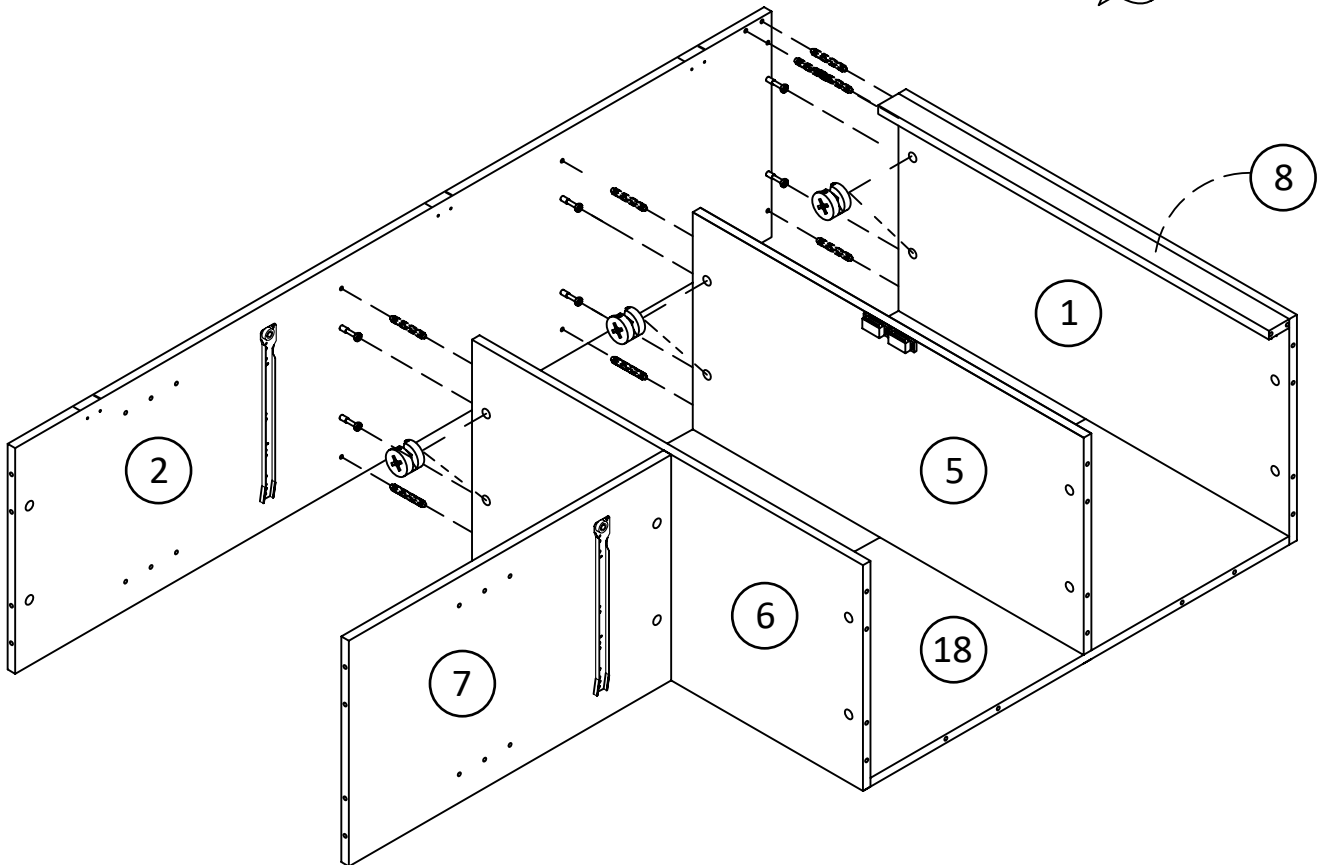
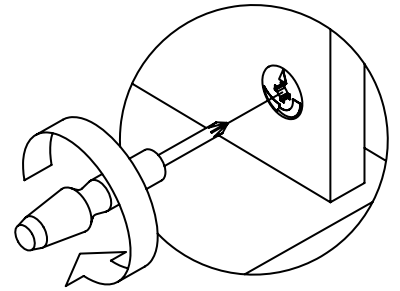

* raw edges are shaded

Step 7

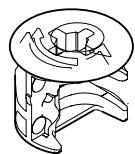
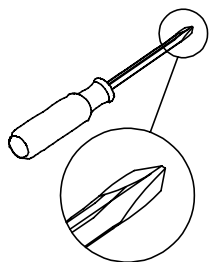

x6
TUD0002



x8
TUD0004

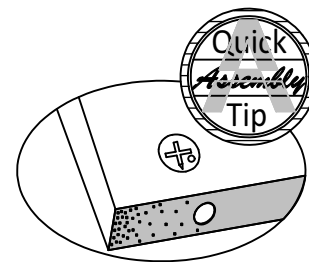

Proper orientation of CAM LOCK

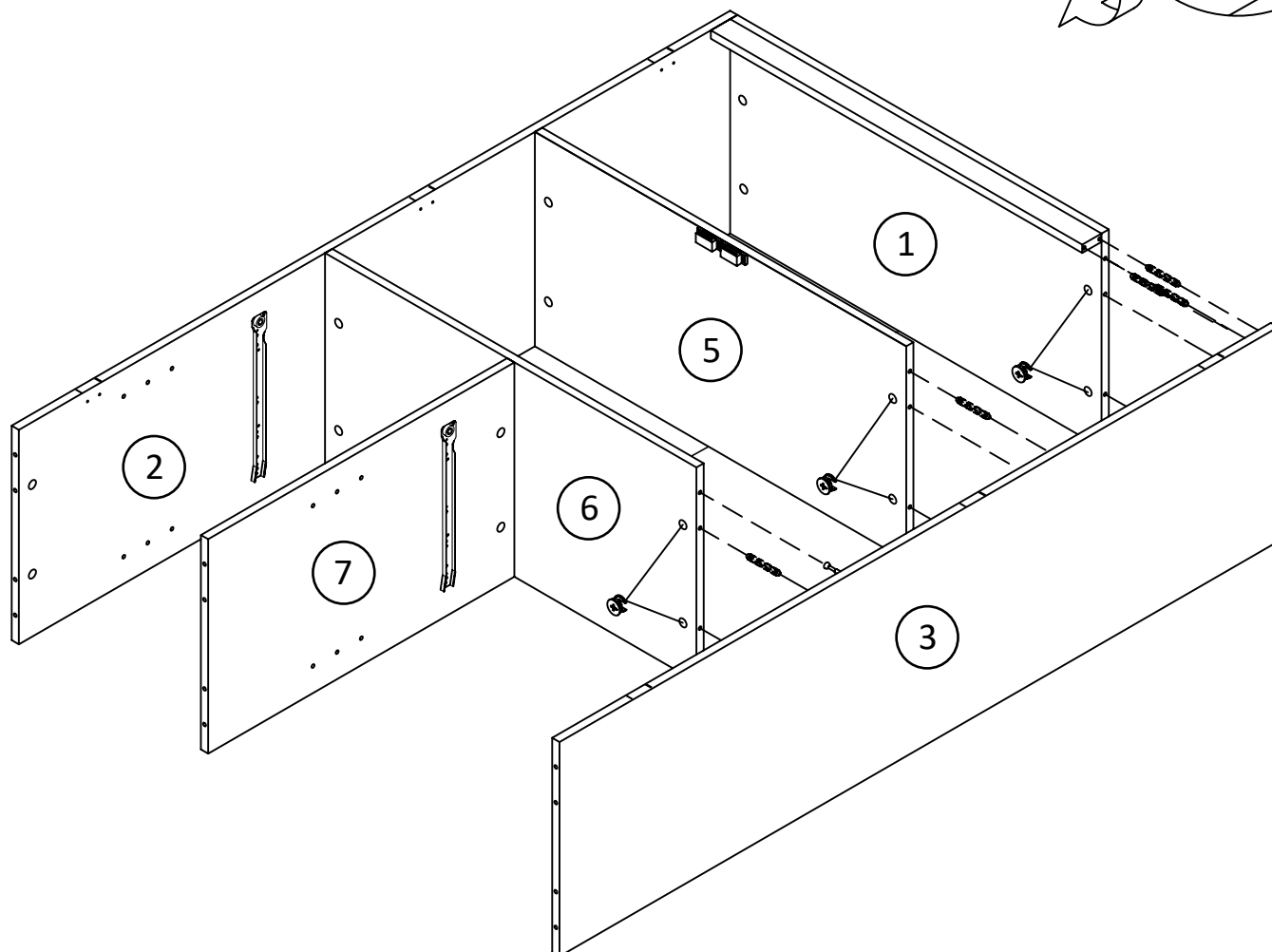
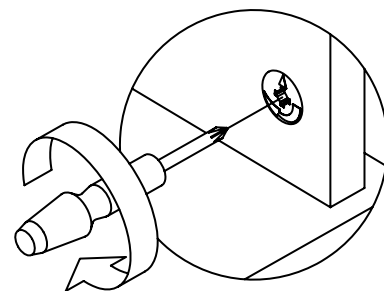
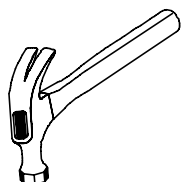

* raw edges are shaded

Step 8

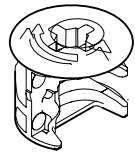
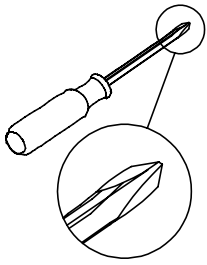

x4
TUD0002



x6
TUD0004

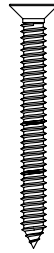

x2
TUD0009

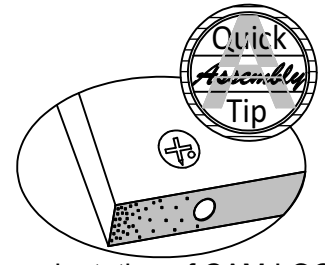

Proper orientation of CAM LOCK

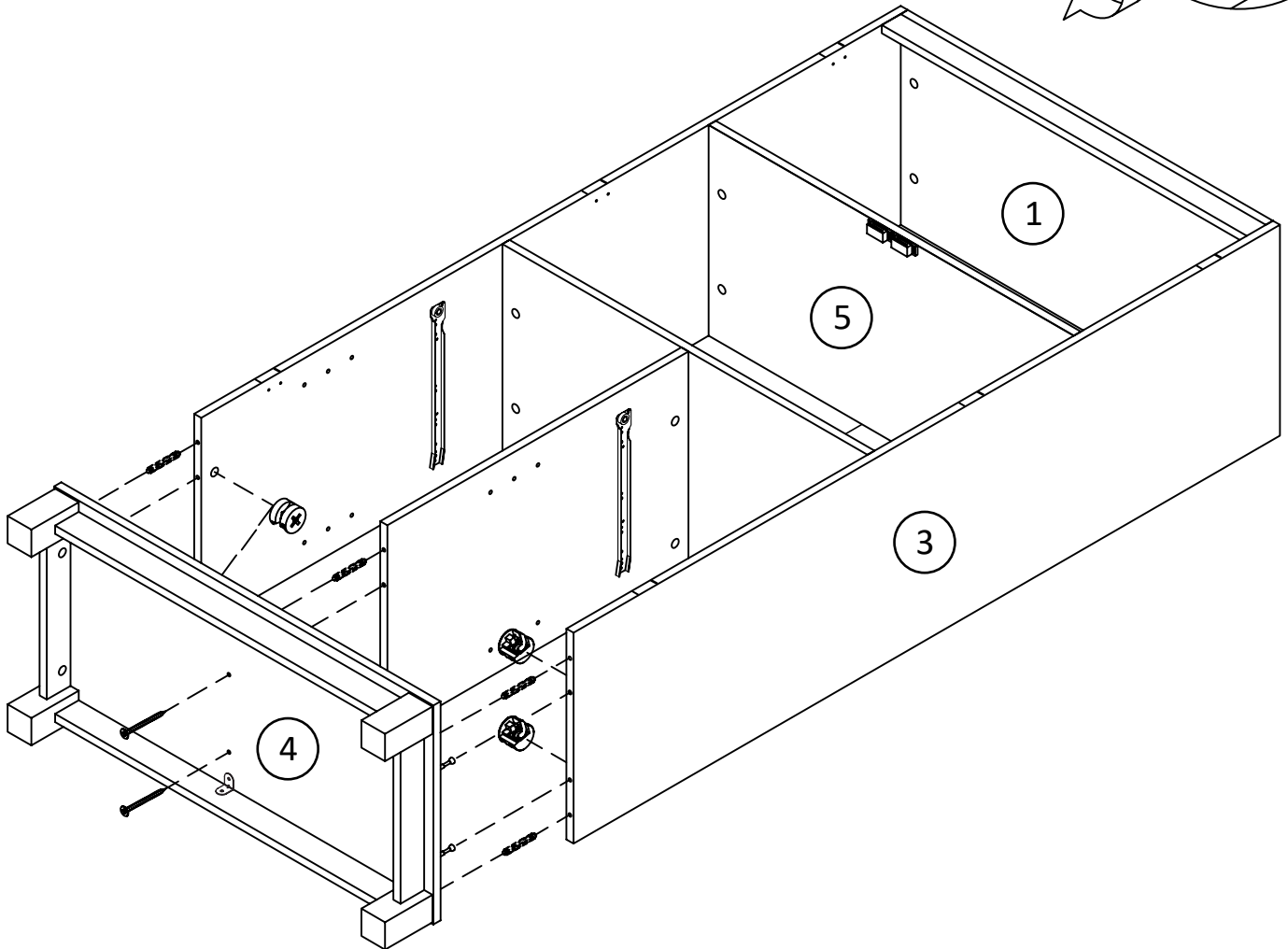
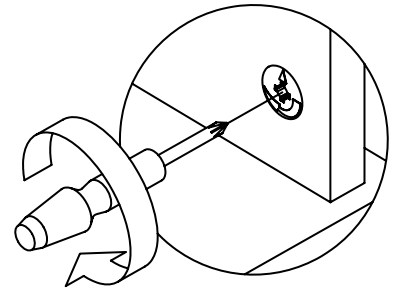
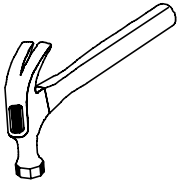

* raw edges are shaded

Step 11

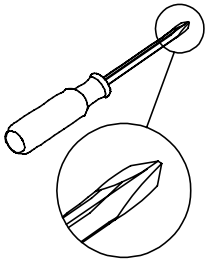

x20
TUD0034

▲ WARNING

Please make sure that the backs are attached securely. All screws must be driven into the parts straight and tightened firmly. Failure to do so could cause instability, product collapse, and / or serious injury.

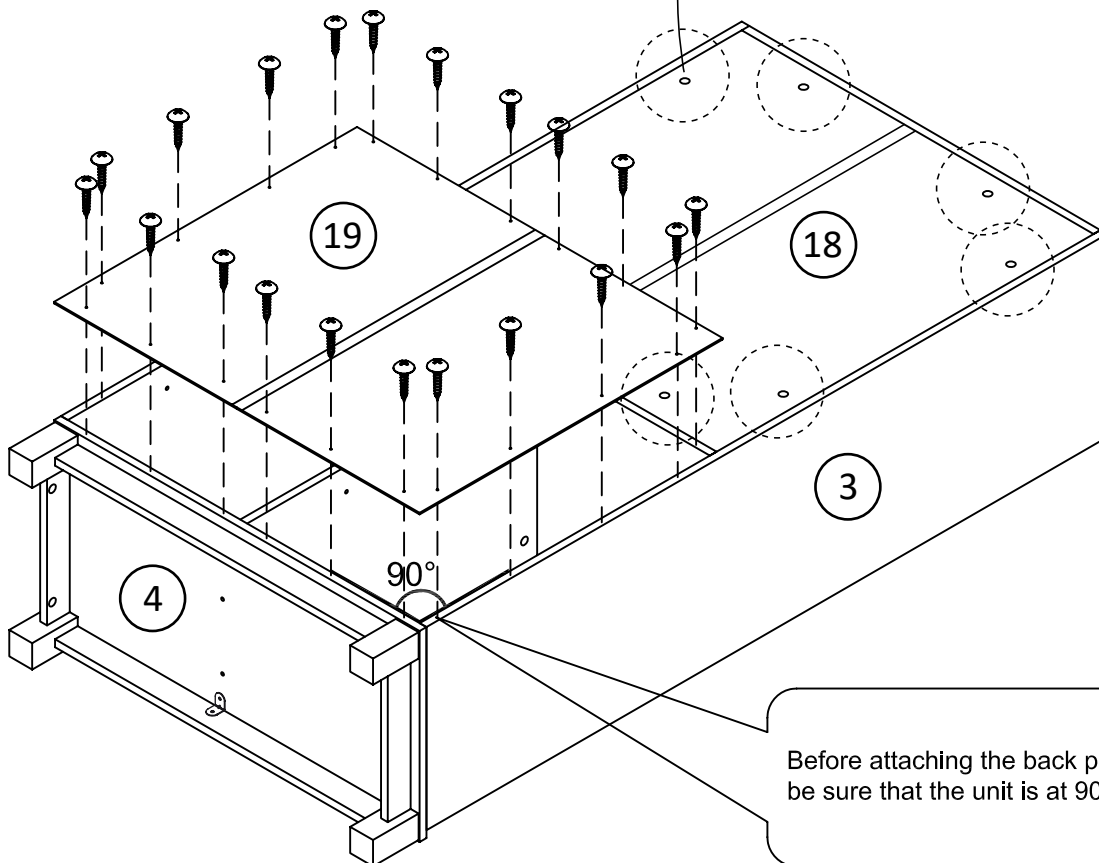
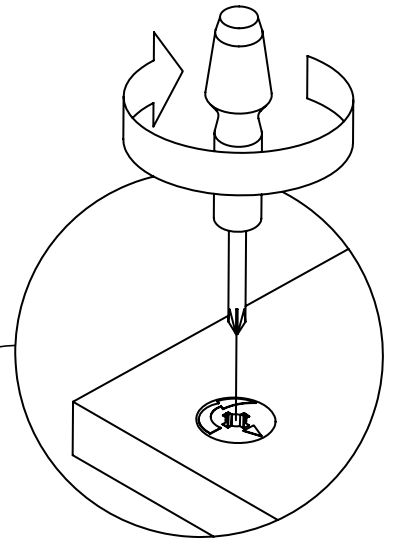

Before attaching the back panel,
be sure that the unit is at 90°.

* raw edges are shaded

Step 12

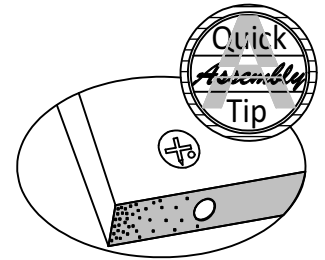
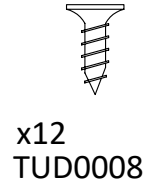
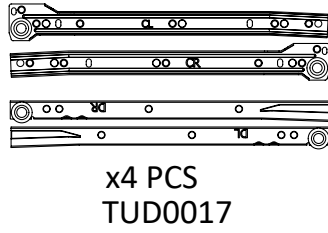
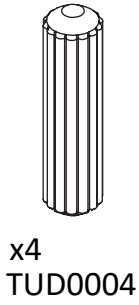
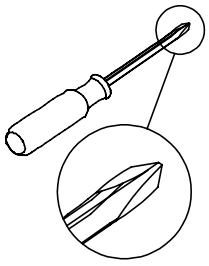

Proper orientation of CAM LOCK

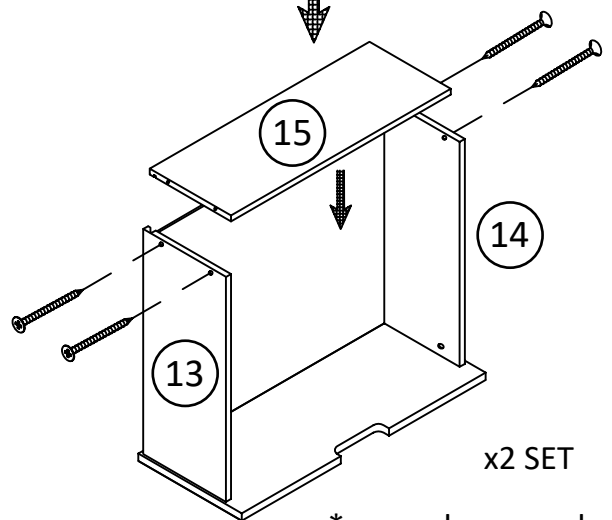
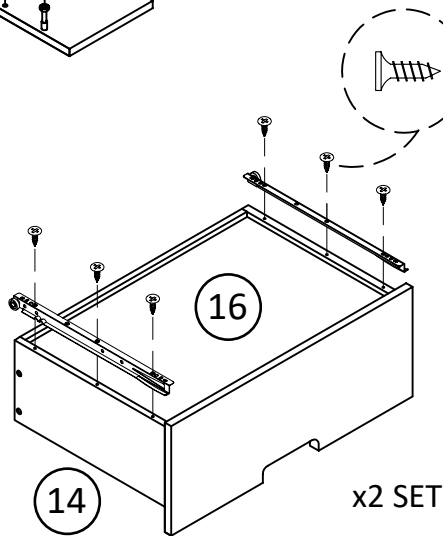
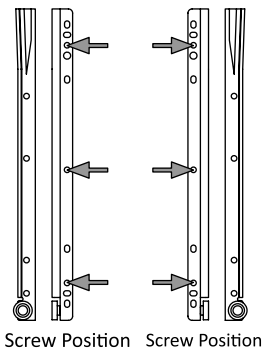
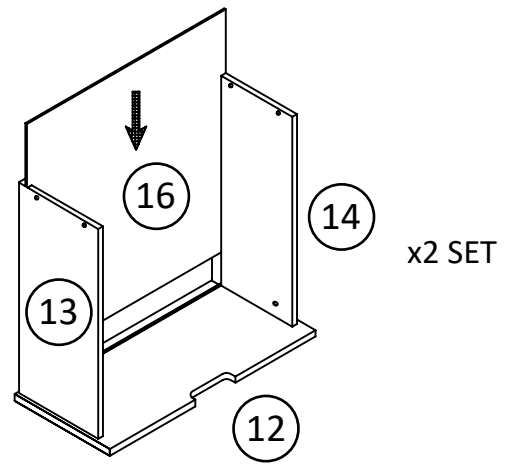
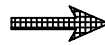
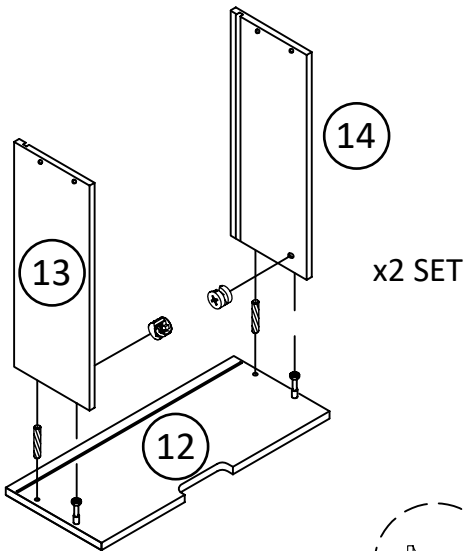
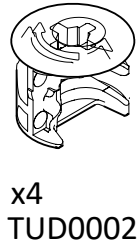
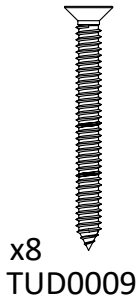

* raw edges are shaded

Step 13

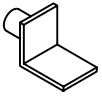

OPTION 1

x8
TUD0035

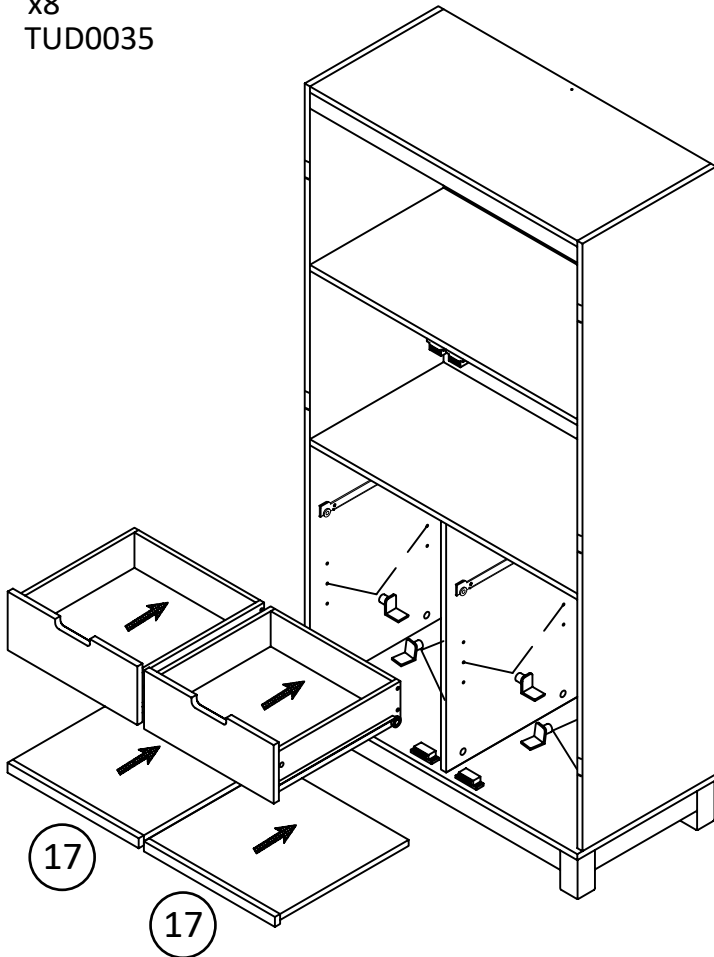

OPTION 2

Cabinet Slide

Drawer Slide

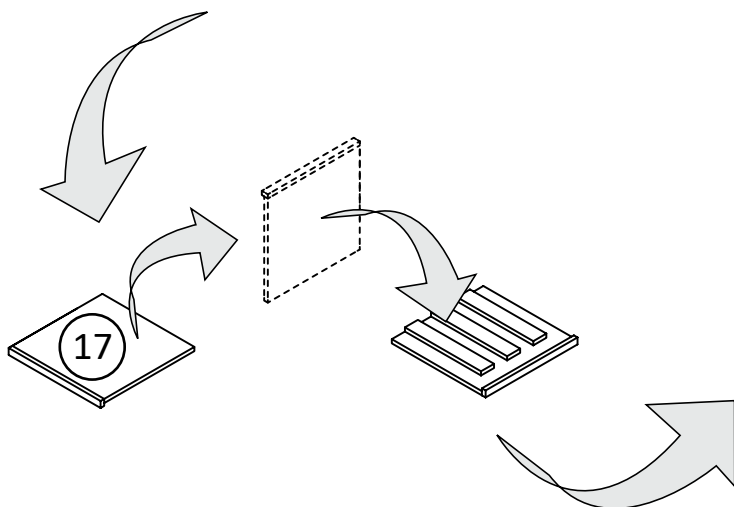
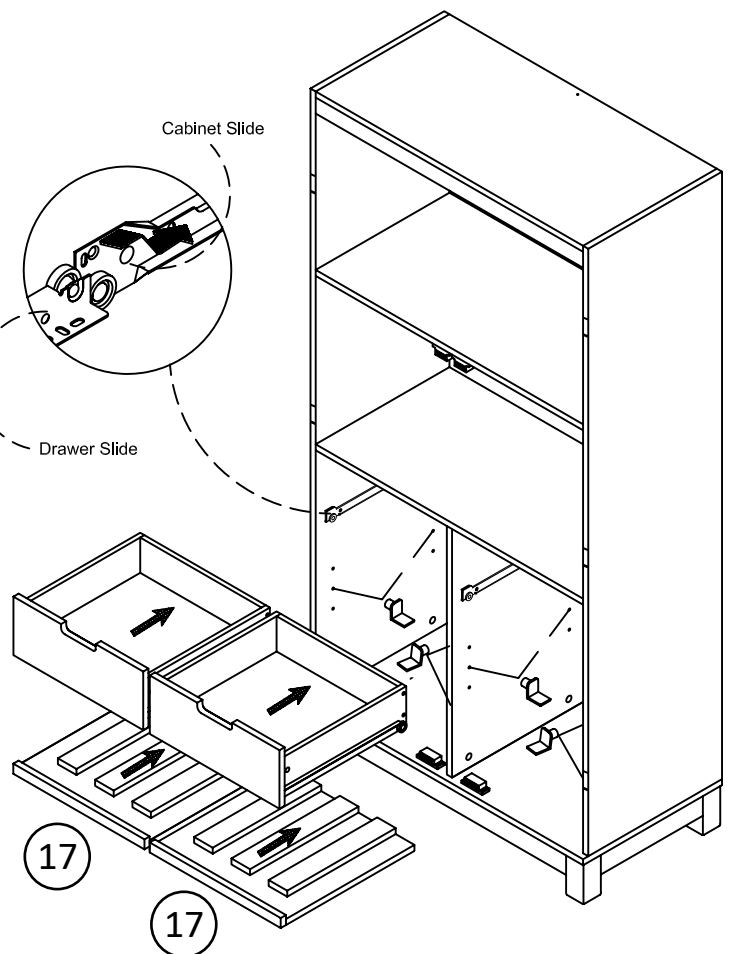

* raw edges are shaded

Step 14

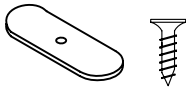
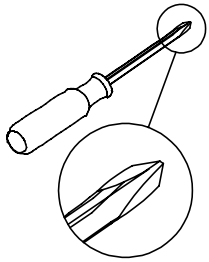

x4 SETS
TUD0031

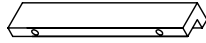

x2
TUD0032

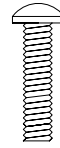

x4
TUD0010

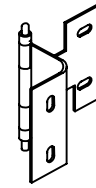

x6
TUD0046

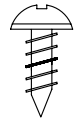

x24
TUD0011

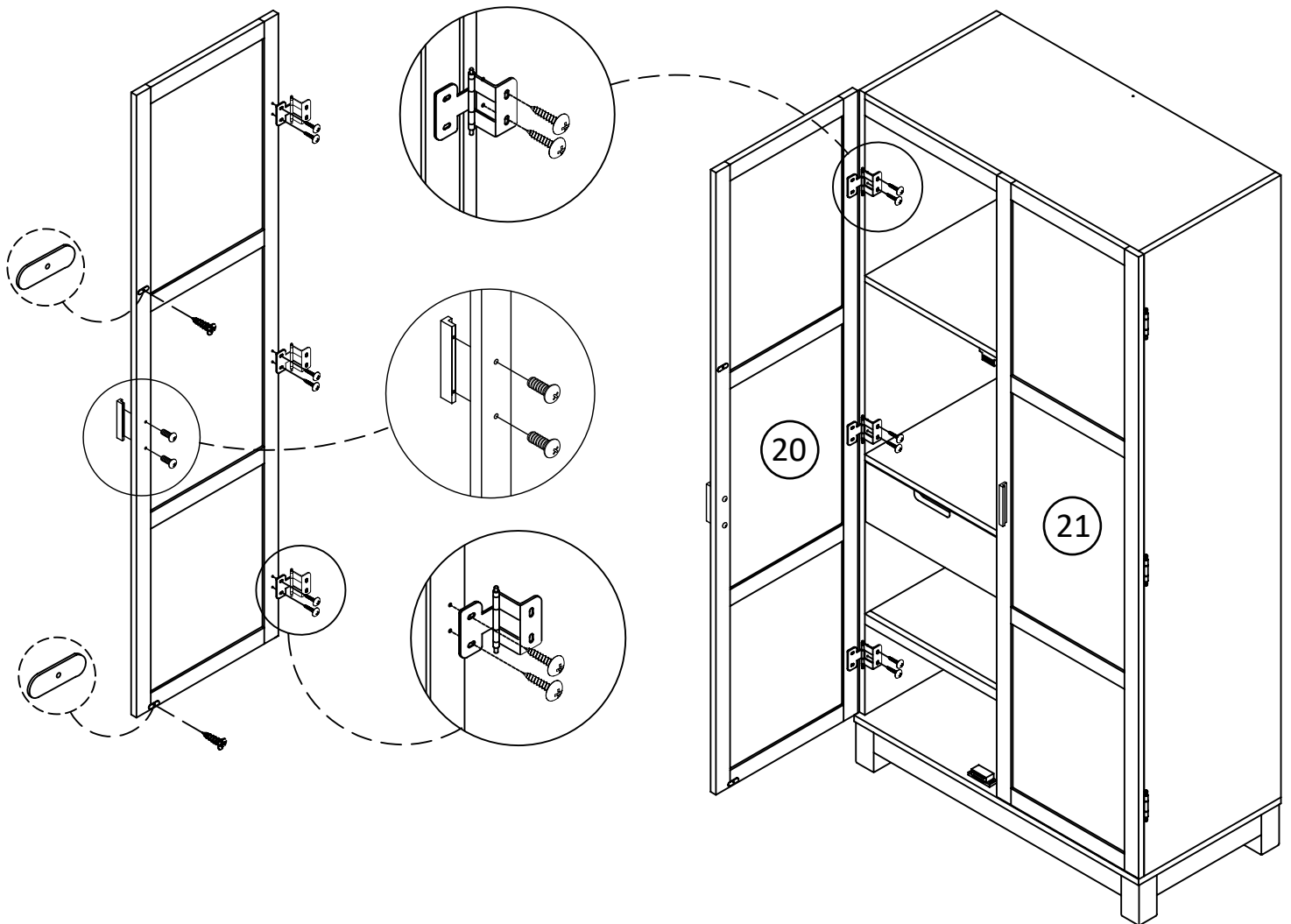

* raw edges are shaded

Step 15

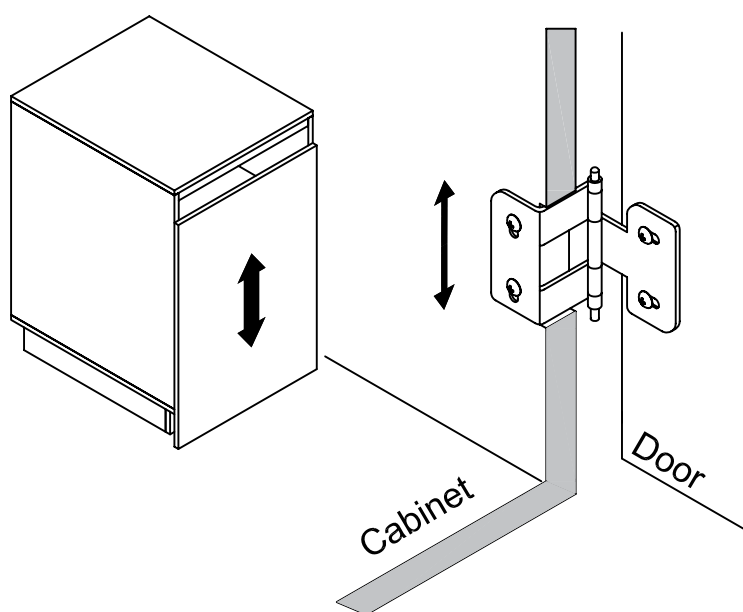
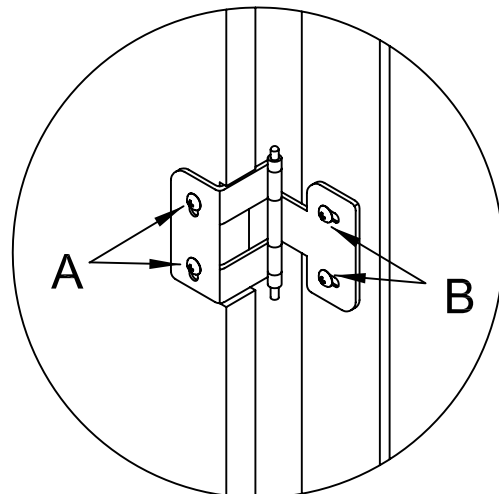

To adjust the vertical height.
Loosen screw "A" and adjust door.
Tighten screw "A".

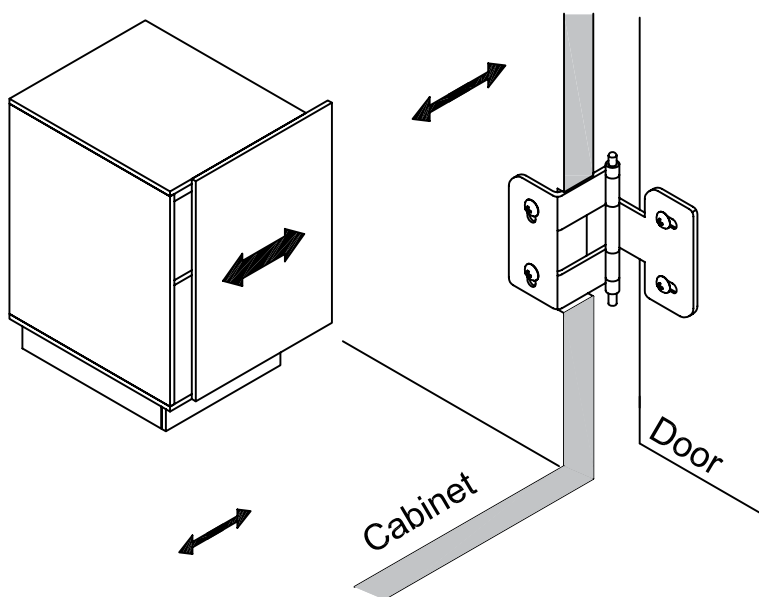

To adjust side ways.
Loosen screw "B" and adjust door.
Tighten screw "B".

* raw edges are shaded

Step 16

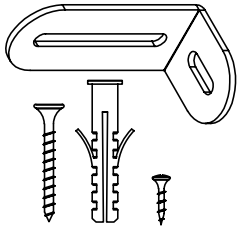

x1 set
TUD0021

Drill a 3/16" (5 mm) diameter hole in the wall. Tap the wall anchor (20) into the hole until it is flush.

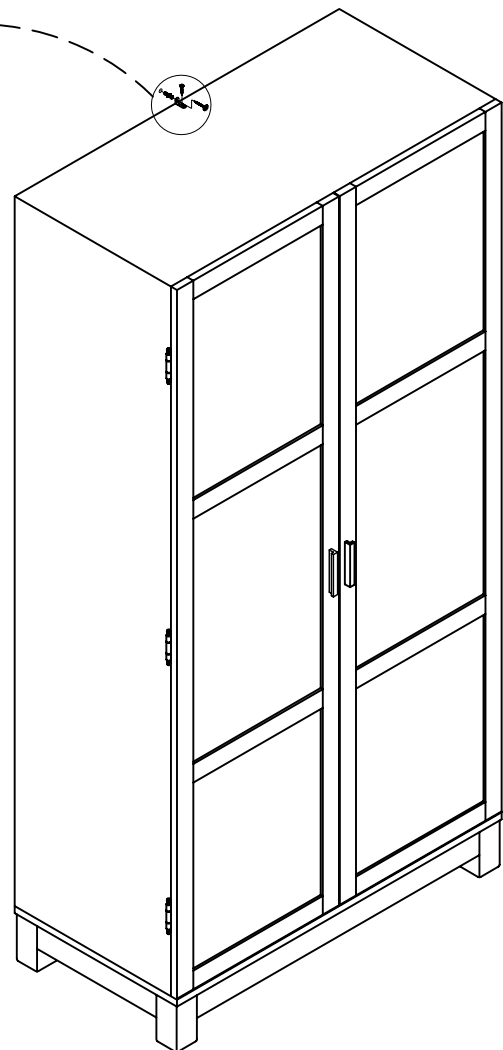
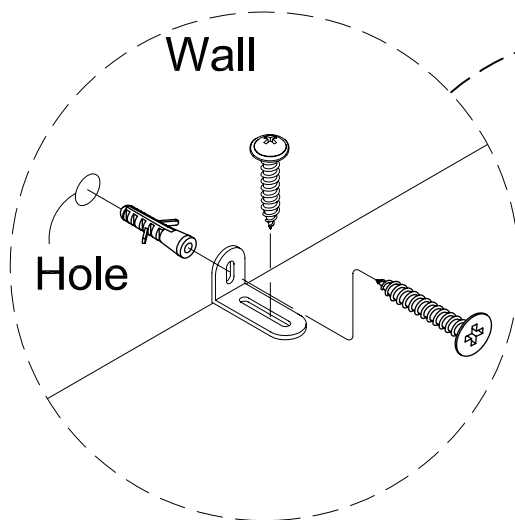

Warning

This unit must be anchored to a stud or wall, as shown. Failure to do so could cause severe injury.

* raw edges are shaded

Maximum Loads

This unit has been designed to support the maximum loads shown. Exceeding these load limits could cause sagging, instability, product collapse, and/or serious injury.

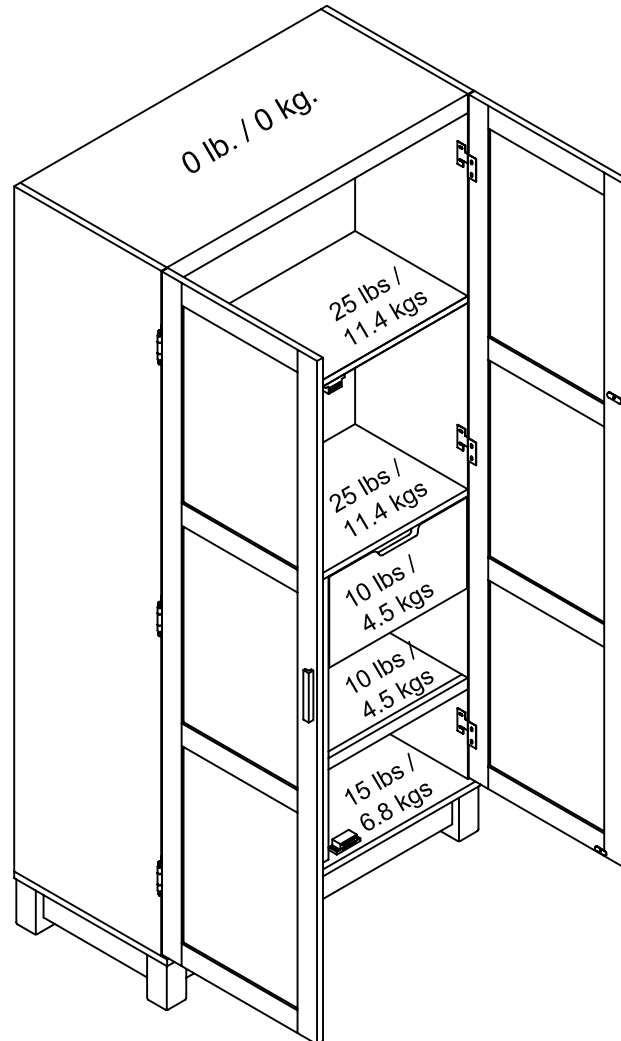

Warning: Risk of serious injury to person - do not place a television on this furniture. This furniture is not approved for use with a television.

Certificate of Conformity

1. This certificate applies to Dorel Home Furnishings, Inc. product identified by this instruction manual.
2. This certificate applies to compliance of this product with the CPSC Ban on Lead-Containing Paint (16 CFR 1303).
3. This product is distributed by: Dorel Home Furnishings, Inc.
410 East First Street South,
Wright City, MO 63390
636-745-3351
4. Site of Manufacturer: Muar, Malaysia.
5. See front page of instruction manual for date of manufacturer.

Register your product to receive the following:



- * New trend details -sneak peek on what's new
- * Surveys -have a voice within our community
- * Exclusive deals and discount codes
- * Quick and easy replacement part service

To register your product, visit Ameriwoodhome.com

5 Star Rating



Visit your local retailer's website, rate your purchased product and leave us some feedback!

We would like to extend a big "Thank You" to all of our customers for taking the time to assemble this Ameriwood Home product, and to give us your valuable feedback

*Thank
You!*

Cubierta Delantera

Este libro de instrucciones contiene información **IMPORTANTE** de seguridad. Por favor lea y manténgalo para referencia en el futuro.

No Regrese este producto! Comuníquese con nuestro amistoso equipo de servicio al cliente para obtener ayuda.

Llámenos al: 1-800-489-3351 (Gratis) Lunes - Viernes 9am - 5pm CST

Visitar: www.ameriwoodhome.com

PRECAUCION

Este mueble puede volcarse y causar graves heridas y/o muerte.

Anclar el mueble a un poste de madera en la pared (si esto se requiere).

No Permita que los niños monten el mueble.

Mantenga los artículos más pesados en los cajones de abajo.

Consejos Útiles (página 2)

- Abra su artículo en el área donde usted planea utilizarlo para evitar levantar y moverlo menos
- Identificar, ordenar y contar las piezas antes de intentar ensamblar
- Las clavijas de compresión se golpean con un martillo
- Las diapositivas están marcadas con una R (derecha) y L (izquierda) para la colocación correcta
- Asegúrese de que siempre este el punto localizado en la parte superior de bloqueador de leva este volteado hacia borde exterior
- Utilizar todos los clavos para el panel de atrás y distribuirlos por igual
- El panel de atrás debe utilizarse para asegurarse de que la unidad quede fija y firme
- No use químicas fuertes ni limpiadores abrasivos en este artículo
- Nunca empuje, tire ni arrastre los muebles

Antes de Que Empieces (página 3)

- Lea cuidadosamente cada paso y siga el orden correcto
- Separar y contar todas sus piezas y hardware
- Dése suficiente espacio para el proceso de ensamble
- Tenga las siguientes herramientas: destornillador de cabeza plana, #2 cabeza Phillips Destornillador y martillo
- Precaución: Si usa un taladro electrónico o un destornillador eléctrico para atornillar, por favor asegúrese que deje de atornillar cuando el tornillos este apretado. Fallar hacer esto puede causar barrer el tornillo

Sistema de fijar el bloqueo de leva (página 3)

Esta sistema de fijar el bloqueo de leva sera usado en todo el proceso ensamble

Identificación de la Junta (página 4&5)

Tamaño no real

Lista de (página 6)

Tamaño real

Lista de (página 7)

Tamaño no real

Página 16

ADVERTENCIA

Asegúrese de que las copias de seguridad estén conectadas de forma segura. Todos los tornillos deben insertarse en las partes rectas y apretarse firmemente. De lo contrario, podría causar inestabilidad, colapso del producto y / o lesiones graves.

Antes de colocar el panel posterior, asegúrese de que la unidad esté a 90°.

Página 18

OPCIÓN 1

OPCIÓN 2

Diapositiva del gabinete

Diapositiva del cajón

Página 20

Para ajustar la altura vertical.

Afloje el tornillo "A" y ajuste la puerta.

Apretar el tornillo "A".

Para ajustar las formas laterales.

Afloje el tornillo "B" y ajuste la puerta.

Apretar el tornillo "B".

Gabinete

Puerta

Página 21

Taladre un orificio de 3/16 "(5 mm) de diámetro en la pared. Golpee ligeramente el anclaje de pared (20) en el orificio hasta que quede al ras.

Advertencia

Esta unidad debe estar anclada a un montante o pared, como se muestra. De lo contrario, podría causar lesiones graves.

Página 22

CARGA MAXIMA

Esta unidad ha sido diseñada para soportar la carga máxima anotada. El exceder estos límites puede causar inestabilidad, colapsarse y/o causar serias lesiones.

ADVERTENCIA: Riesgo de lesiones a las personas - no coloque un televisor sobre muebles.

Este mueble no está aprobado para su uso con un televisor.

Página 23

Registre su producto para recibir lo siguiente:

- * Nuevos detalles sobre las tendencias - Sneek echa un vistazo a lo nuevo
 - * Encuestas - tener una voz dentro de nuestra comunidad
 - * Ofertas exclusivas y códigos de descuento
- Servicio de piezas de repuesto rápido y fácil

Para registrar su producto, visite Ameriwoodhome.com

5 estrellas

Visite el sitio web de su distribuidor local, califique su producto comprado y déjenos algunos comentarios!

Nos gustaría extender un gran “Gracias” a todos nuestros clientes por tomarse el tiempo para montar este producto Ameriwood Home, y para darnos sus valiosos comentarios

Gracias!

capot avant

Ce livret d'instructions contient d'importantes informations de sécurité. S'il vous plaît lire et conserver pour référence ultérieure.

Ne pas retourner ce produit! Contactez notre équipe de service à la clientèle amical pour aider.

Appel: 1-800-489-3351 (gratuit) Lundi - Vendredi 9am - 5pm CST

Visite: www.ameriwoodhome.com

MISE EN GARDE

Ce mobilier peut basculer et causer des blessures graves et / ou la mort.

Ancrer les meubles à un poteau en bois sur le mur (si cela est nécessaire).

Ne laissez pas les enfants monter l'armoire.

Gardez les articles plus lourds dans les tiroirs ci-dessous.

Conseil (page 2)

- Ouvrez votre article dans la zone où vous prévoyez de l'utiliser pour éviter de soulever et déplacer moins
- Identifier, trier et compter les pièces avant de monter
- bouchons de compression sont frappés avec un marteau
- Les lames sont marqués par un R (droite) et L (à gauche) pour le positionnement correct
- Assurez-vous toujours ce point, je Aviana sur le dessus de la came de blocage ce bord extérieur volteadohacia
- Utilisez tous les clous du panneau arrière et les distribuer également
- Le panneau arrière doit être utilisé pour faire en sorte que l'unité est fixe et ferme
- Ne pas utiliser de produits chimiques ou de produits abrasifs sur cet article
- Ne jamais pousser, tirer ou meubles de glisser

Avant de commencer (page 3)

- Lire attentivement chaque étape et suivre l'ordre
- separate et compter toutes les pièces et matériel
- Dése un espace suffisant pour le processus d'assemblage
- Soyez les outils suivants: tournevis Phillips n ° 2 tête
Tournevis et un marteau
- Precaución: Si vous utilisez une perceuse électronique ou un tournevis électrique à vis, s'il vous plaît faire arrêter le vissage lorsque le tonillos ce serré. Le non-respect cela peut provoquer balayer la vis

Système de régler le verrou de came (page 3)

Ce système de fixation du verrou de came sera utilisé tout au long du processus d'assemblage

Identification du Conseil (page 4 et 5)

pas la taille réelle

Liste (Page 6)

taille réelle

Liste (page 7)

pas la taille réelle

Page 16

ATTENTION

Assurez-vous que les sauvegardes sont bien connectées. Toutes les vis doivent être insérées dans les parties droites et serrées fermement. Sinon, cela pourrait provoquer une instabilité, un effondrement du produit et / ou des blessures graves.

Avant de fixer le panneau arrière, assurez-vous que l'unité est à 90°.

Page 18

OPTION 1

OPTION 2

Glissière

Glissière de tiroir

Page 20

Pour ajuster la hauteur verticale.

Desserrez la vis "A" et réglez la porte.

Serrez la vis "A".

Pour régler les côtés.

Desserrez la vis "B" et ajuster la porte.

Serrez la vis "B".

Cabinet

Porte

page 21

Percez un trou de 3/16 po (5 mm) de diamètre dans le mur et enfoncez l'ancrage mural (20) dans le trou jusqu'à ce qu'il affleure.

Attention

Cette unité doit être ancrée à un poteau ou un mur, comme indiqué. Ne pas le faire pourrait causer des blessures graves.

Page 22

MAXIMUM DE CHARGE

Cet appareil est conçu pour supporter la charge maximale enregistrée. Le dépassement de ces limites peut provoquer l'instabilité, l'effondrement et / ou causer des blessures graves.

AVERTISSEMENT: Risque de blessures aux personnes - ne placez pas la télévision sur les meubles.

Ce mobilier est pas approuvé pour une utilisation avec une télévision.

Page 23

Enregistrez votre produit pour recevoir les éléments suivants:

- * De nouveaux détails sur les tendances - Sneek vérifier la nouvelle
 - * Sondages - ont une voix dans notre communauté
 - * Offres exclusives et des codes de réduction
- Service de pièces de rechange rapide et facile

Pour enregistrer votre produit, visitez Ameriwoodhome.com

5 étoiles

Visitez le site Web de votre distributeur local, classez votre produit acheté et laissez des commentaires!

Nous aimerions étendre un grand "Merci" à tous nos clients pour prendre le temps de rassembler ce produit Ameriwood Home et de nous faire part de vos précieux commentaires

Merci!